



F.LLI TASSALINI s.p.a.





La F.LLI TASSALINI OFFICINA MECCANICA S.P.A. opera nel campo delle produzioni meccaniche da oltre 80 anni e da 40 anni costruisce valvole e raccordi tecnologicamente avanzati di sua esclusiva progettazione e fabbricazione per l'industria agroalimentare, enologica, delle bevande, chimica e farmaceutica.

La completa gamma dei prodotti è realizzata in acciaio inossidabile AISI 304L e AISI 316L ed è ricavata da materiale laminato o da particolari stampati a caldo, solubilizzati e lavorati meccanicamente; speciale accuratezza è dedicata alla lavorazione delle parti filettate e l'eliminazione delle parti finali delle filettature è eseguita con operazioni meccaniche a garanzia di assoluta sicurezza durante la manipolazione dei pezzi.

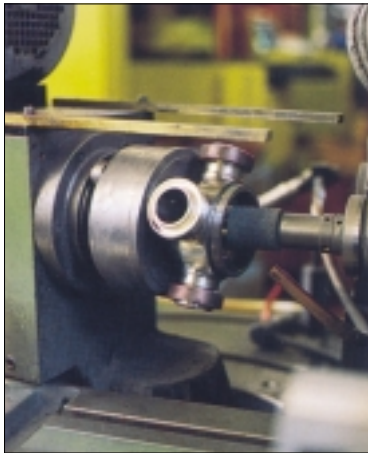

La gamma degli articoli prodotti dalla F.Lli Tassalini s.p.a. è fabbricata secondo le principali norme internazionali (DIN, SMS, RJT BS, ISS IDF, Gas, Eno, Macon e Clamp) e comprende raccordi; riduzioni; tee; curve; filtri e specole; rubinetti; valvole di regolazione, sicurezza e ritegno; valvole a farfalla di

diversi tipi, a comando manuale e pneumatico, predisposti per l'inserimento di componenti elettrici; valvole a sfera; valvole pneumatiche, 3-A e di drenaggio; valvole a membrana.

Tutti i prodotti sono normalmente disponibili a magazzino nelle misure standard e l'ufficio tecnico della F.Lli Tassalini s.p.a. è a disposizione per lo studio di eventuali pezzi speciali necessari alla realizzazione di particolari impianti.

Gli oltre 7000 metri quadrati di superficie nella nuova sede di Peschiera Borromeo hanno garantito una più puntuale organizzazione della produzione, dei controlli e degli stoccaggi a magazzino e hanno consentito l'installazione di una serie di macchine utensili di ultima generazione, di concezione estremamente avanzata e operanti con programmi altamente sofisticati.

Una meticolosa serie di controlli e collaudi rappresenta un ulteriore aspetto operativo che concorre a garantire la qualità dei raccordi e delle valvole F.Lli Tassalini, riconosciuta a livello internazionale.

La F.Lli Tassalini s.p.a. è presente con una rete capillare di propri rivenditori sul mercato europeo e mondiale.

F.LLI TASSALINI OFFICINA MECCANICA S.P.A. has been operating in the machined products industry for over 80 years and for the last 40 years has made high-tech valves and fittings of its own exclusive design and manufacture for the food, wine, beverages, chemical and pharmaceutical industries.

All F.Lli Tassalini s.p.a. products are made of AISI 304L and AISI 316L stainless steel from hot-rolled material or press-forged sections, solution heat-treated and machined. Special care is given to the machining of threaded parts while the elimination of threaded ends is carried out by machining to ensure absolute safety to those handling the parts.

The range of articles produced by F.Lli Tassalini s.p.a. is manufactured in conformity with the main international standards (DIN, SMS, RJT BS, ISS IDF, BSP, Eno, Macon and Clamp standards) and includes unions; reducers; tees; bends; filters and sight glasses; plug cocks; flow control, relief and check valves; different types of butterfly valves with manual or pneumatic controls, designed for the insertion of electrical components; ball valves; pneumatic, 3-A, and drainage valves; diaphragm valves.

All products are stocked in standard dimensions and our engineering department is at the customer's complete disposal to develop customized parts for special systems.

F.Lli Tassalini's new premises in Peschiera Borromeo cover 7000 square metres making it possible to achieve accurate production planning, control and inventory, as well as allowing the installation of a series of latest-generation machine tools, conceived at the most advanced level and operating with highly sophisticated programmes.

A meticulous testing and inspection procedure is an additional aspect of operations which helps ensure the quality of F.Lli Tassalini fittings and valves, recognized worldwide.

F.Lli Tassalini s.p.a. is represented by a complete network of dealers and distributors on European and world markets.



F.LLI TASSALINI OFFICINA MECCANICA S.P.A. opère depuis plus de 80 ans dans le secteur des productions mécaniques et depuis 40 ans l'entreprise fabrique des vannes et des raccords d'un très haut niveau technologique, entièrement conçus et réalisés par elle-même, destinés à l'industrie agro-alimentaire, oenologique, des boissons, chimique et pharmaceutique.

Sa gamme complète de produits est réalisée en acier inoxydable AISI 304L et AISI 316L et est obtenue à partir de matériaux laminés ou de pièces moulées à chaud, solubilisées et usinées mécaniquement. Un soin tout particulier est réservé à l'usinage des parties filetées et l'élimination des extrémités des filetages est réalisée avec des opérations mécaniques garantissant une sécurité absolue pendant le maniement des pièces.

La gamme des articles produits par Flli Tassalini s.p.a. est fabriquée conformément aux principales normes internationales (DIN, SMS, RJT BS, ISS IDF, Gas, Eno, Macon et Clamp) et se compose de raccords; réductions; tés; coudes; filtres et regards; robinets; vannes de réglage, soupapes de sûreté et clapets de retenue; vannes papillon de différents types, à commande manuelle ou pneumatique, prévus pour l'insertion de composants électriques; vannes à boule; vannes pneumatiques, 3-A et de drainage; vannes à membrane.

Tous les produits sont disponibles en stock dans les mesures standard. Le bureau technique de Flli Tassalini s.p.a. est en outre disponible pour la conception de pièces spéciales s'avérant nécessaires pour la réalisation d'installations particulières.

Avec une superficie de plus de 7000 m², le nouveau siège de Peschiera Borromeo assure une organisation plus rationnelle de la production, des contrôles et du stockage. Il a également permis d'installer toute une série de machines-outils de la dernière génération, d'une conception d'avant-garde et opérant avec des programmes très sophistiqués.

Une série méticuleuse de contrôles et d'essais représente un autre aspect du travail qui permet de garantir la qualité des raccords et des vannes Flli Tassalini, une qualité reconnue au niveau international.

La présence de Flli Tassalini s.p.a. sur les marchés européens et mondiaux est assurée grâce à son réseau très serré de revendeurs.

F.LLI TASSALINI OFFICINA MECCANICA S.P.A. trabaja en el sector de la producción mecánica desde hace más de 80 años y desde hace 40 años construye válvulas y racores tecnológicamente de vanguardia, de su exclusivo diseño y fabricación, para la industria agroalimenticia, enológica, de bebidas, química y farmacéutica.

La gama completa de productos está realizada de acero inoxidable AISI 304L y AISI 316L y se obtiene a partir de material laminado o de piezas estampadas en caliente, solubilizadas y elaboradas mecánicamente; al maquinado de las piezas roscadas se le dedica un esmero especial mientras que la eliminación de las partes terminales de las roscas se efectúa mediante operaciones mecánicas que garantizan totalmente la seguridad durante la manipulación de las piezas.

La gama de artículos producidos por Flli Tassalini s.p.a. está fabricada según las principales normas internacionales (DIN, SMS, RJT BS, ISS IDF, Gas, Eno, Macon y Clamp) e incluye racores; reducciones; tes; codos; filtros y mirillas; grifos; válvulas de regulación, de seguridad y de retención; válvulas de mariposa de diferentes tipos, con mando manual o neumático, predisuestos para conexiones con componentes eléctricos; válvulas de bola; válvulas neumáticas, 3-A y de drenaje; válvulas de membrana.

Normalmente todos los productos se encuentran disponibles en el almacén en las medidas estándar. Para la realización de sistemas especiales el departamento técnico de Flli Tassalini s.p.a. está a disposición de sus clientes para estudiar las piezas especiales que pudieran ser necesarias.

Los más de 7000 metros cuadrados de superficie en la nueva sede de Peschiera Borromeo garantizan una mejor organización de la producción, de los controles y de las existencias del almacén, y han permitido instalar una serie de máquinas herramientas de última generación, de concepción muy avanzada y que trabajan con programas altamente sofisticados.

Una meticulosa serie de controles y pruebas representa otro de los aspectos operativos que ayudan a garantizar la calidad de los racores y de las válvulas Flli Tassalini, reconocida en los mercados internacionales.

Flli Tassalini s.p.a. está presente sobre el mercado europeo y mundial a través de una red muy extendida y ramificada de sus propios revendedores.



ACCIAI
STEELS

ACIERS
ACEROS

La completa gamma dei nostri prodotti è realizzata in acciaio inossidabile AISI 304L e AISI 316L.

The complete range of our products is made of AISI 304L and AISI 316L stainless steel.

La gamme complète de nos produits est réalisée en acier inoxydable AISI 304L et AISI 316L.

La gama completa de nuestros productos está realizada en acero inoxidable AISI 304L y AISI 316L.

TIPDI ACCIAIO INOSSIDABILE E LORO CORRISPONDENZA CON LE PRINCIPALI NORMATIVE ESTERE
STAINLESS STEEL TYPES AND THEIR CORRESPONDING INTERNATIONAL STANDARDS

TYPES D'ACIERS INOXYDABLES ET LEUR CORRESPONDANCE AVEC LES PRINCIPALES NORMES INTERNATIONALES

TIPOS DE ACERO INOXIDABLE Y SU CORRESPONDENCIA CON LAS PRINCIPALES NORMAS EXTRANJERAS

Italia Italy Italie Italia	USA USA USA USA	Germania Germany Allemagne Alemania	Francia France France Francia	Svezia Sweden Suède Suecia	Gran Bretagna Great Britain Grande-Bretagne Gran Bretaña
UNI	AISI	WERKSTOFF	AFNOR	SIS	BSI
X2CrNi18-11	304L	1.4306	Z2CN18-10	2352	304S11
X2CrNiMo17-12	316L	1.4404	Z2CND17-12	2348	316S11

COMPOSIZIONE CHIMICA
CHEMICAL COMPOSITION
COMPOSITION CHIMIQUE
COMPOSICIÓN QUÍMICA

CARATTERISTICHE MECCANICHE
MECHANICAL CHARACTERISTICS
CARACTÉRISTIQUES MÉCANIQUES
CARACTERÍSTICAS MECÁNICAS

AISI 304L			AISI 316L		
			C	≤	0,03
C	≤	0,03	Cr	≥	17,00
Cr	≥	19,00	Ni	≥	12,00
Ni	≥	10,00	Mo	≥	2,25
Si	≤	0,25	Si	≤	0,30
Mn	≤	1,30	Mn	≤	1,40
S	≤	0,02	S	≤	0,02
P	≤	0,02	P	≤	0,02

AISI 304L			AISI 316L				
Hd	140	÷	190	Hd	18	÷	220
R	55	÷	65	R	65	÷	75
S	≥	22		S	≥	23	
AP5	≥	50		AP5	≥	50	
C	≥	65		C	≥	60	
KI	≥	25		KI	≥	18	

FINITURE	FINISSAGES	
FINISHES	ACABADOS	

GRIT	Max R _a μm	Max R _a μ"
120	1,01 - 1,14	40 - 45
150	0,76 - 0,89	30 - 35
240	0,38 - 0,51	15 - 20
400	≤ 0,2	≤ 8

■ 120 GRIT

- Finitura meccanica di precisione / satinatura esterna e interna.
- Precision machine finish / external and internal glazing.
- Finissage mécanique de précision / satinage externe et interne.
- Acabado mecánico de precisión / satinado exterior e interior.

■ 150 GRIT

- Finitura LS: lucidatura esterna e satinatura interna.
- LS finish: external polishing and internal glazing.
- Finissage LS: polissage extérieur et satinage intérieur.
- Acabado LS: pulido exterior y satinado interior.

■ 240 GRIT

- Finitura LL: lucidatura esterna e interna.
- LL finish: external and internal polishing.
- Finissage LL: polissage extérieur et intérieur.
- Acabado LL: pulido exterior e interior.

■ 400 GRIT

- Finitura LE: lucidatura elettrolitica.
- LE finish: electrolytic polishing.
- Finissage LE: polissage électrolytique.
- Acabado LE: pulido electrolítico.

NORME	NORMES
STANDARDS	NORMAS

La completa gamma dei nostri prodotti è fabbricata secondo le principali norme internazionali.

The complete range of our products is manufactured in conformity with the main international standards.

La gamme complète de nos produits est fabriquée conformément aux principales normes internationales.

La gama completa de nuestros productos está fabricada según las principales normas internacionales.

- DIN
- SMS
- RJT BS
- ISS IDF
- Clamp
- Gas
- Eno
- Macon

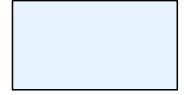

CURVE

- Fabbricate in acciaio inossidabile AISI 304L e AISI 316L.
- Ricavate da tubi elettrouniti con sistema TIG, laminati a freddo e solubilizzati in atmosfera controllata.
- Calibrate internamente ed esternamente al fine di ottenere una buona circolarità.
- Intestate alle estremità per assicurare la perfetta ortogonalità dei piani.
- Finitura standard: lucidatura esterna e satinatura interna grana 120 (max R_a μm 1,01-1,14; max R_a μm 40-45) norme DIN; satinatura esterna e interna grana 120 norme SMS, BS, ISS; lucidatura esterna e interna grana 150 (max R_a μm 0,76-0,89; max R_a μm 30-35) norme Clamp. A richiesta, lucidatura esterna e interna grana 240 (max R_a μm 0,38-0,51; max R_a μm 15-20), lucidatura elettrolitica grana 400 (max R_a μm \leq 0,2; max R_a μm \leq 8).
- Produzione standard: curve a 45°, 90°, 180°. A richiesta, disponibili in differenti spessori e corredate di raccordi mandrinati o saldati.

BENDS

- Made of AISI 304L and AISI 316L stainless steel.
- Made from pipe electrojointed with the TIG method, cold-rolled and solution heat-treated in controlled atmosphere.
- Gauged inside and outside to obtain precise roundness.
- Faced on the ends to ensure perfect right angles of planes.
- Standard finish: 120 grain external polishing and internal glazing (max R_a μm 1.01-1.14; max R_a μm 40-45) to DIN standards; 120 grain external and internal glazing to SMS, BS and ISS standards; 150 grain external and internal polishing (max R_a μm 0.76-0.89; max R_a μm 30-35) to Clamp standards. On request 240 grain external and internal polishing (max R_a μm 0.38-0.51; max R_a μm 15-20); 400 grain electrolytic polishing (max R_a μm \leq 0.2; max R_a μm \leq 8).
- Standard production: 45°, 90° and 180° bends. On request, available in different thicknesses and available with expanded or welded unions.

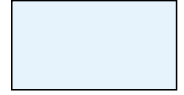

COUDES

- Fabriquées en acier inoxydable AISI 304L et AISI 316L.
- Obtenues à partir de tubes électrosoudés avec le système TIG, laminés à froid et solubilisés en atmosphère contrôlée.
- Calibrées à l'intérieur et à l'extérieur afin d'obtenir une bonne circularité.
- Façonnées aux extrémités pour assurer l'orthogonalité parfaite des plans.
- Finissage standard: polissage extérieur et satinage intérieur grain 120 (max R_a μm 1,01-1,14; max R_a μm 40-45) normes DIN; satinage extérieur et intérieur grain 120 normes SMS, BS, ISS; polissage extérieur et intérieur grain 150 (max R_a μm 0,76-0,89; max R_a μm 30-35) normes Clamp. Sur demande, polissage extérieur et intérieur grain 240 (max R_a μm 0,38-0,51; max R_a μm 15-20), polissage électrolytique grain 400 (max R_a μm \leq 0,2; max R_a μm \leq 8).
- Production standard: coudes a 45°, 90°, 180°. Sur demande, disponibles en différentes épaisseurs et munies de raccords dudgeonnés ou soudés.

CODOS

- Fabricados de acero inoxidable AISI 304L y AISI 316L.
- Obtenidos a partir de tubos unidos eléctricamente mediante el sistema TIG, laminados en frío y solubilizados en atmósfera controlada.
- Calibrados interior y exteriormente con la finalidad de obtener una forma circular perfecta.



- Trabajados en los extremos para asegurar que las superficies sean perfectamente ortogonales.
- Acabado estándar: pulido exterior y satinado interior grano 120 (max R_a μm 1,01-1,14; max R_a μm 40-45) normas DIN; satinado exterior e interior grano 120 normas SMS, BS, ISS; pulido exterior e interior grano 150 (max R_a μm 0,76-0,89; max R_a μm 30-35) normas Clamp. A pedido, pulido exterior e interior grano 240 (max R_a μm 0,38-0,51; max R_a μm 15-20), pulido electrolítico grano 400 (max R_a μm \leq 0,2; max R_a μm \leq 8).
- Producción estándar: codos a 45°, 90°, 180°. A pedido, se pueden suministrar en diferentes espesores y se pueden equipar con racores mandrilados o soldados.



**CURVA 45° EL.
BEND 45° PE.
COUDE 45° BL.
CODO 45° EL.**

300 L

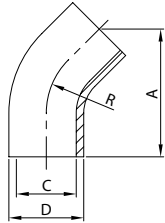

DN	A	C	D	R	gr
12	45,0	10,0	12,0	26,0	40
18	60,0	16,0	18,0	35,0	50
22	65,0	20,0	22,0	40,0	60
28	73,0	25,0	28,0	50,0	62
34	83,0	31,0	34,0	55,0	85
40	89,0	37,0	40,0	60,0	120
52	103,0	49,0	52,0	70,0	190
70	108,0	66,0	70,0	80,0	390
85	120,0	81,0	85,0	90,0	470
101	137,0	97,6	101,6	110,0	930
104	137,0	100,0	104,0	100,0	930

**CURVA 90° ES.
BEND 90° WE.
COUDE 90° BS.
CODO 90° ES.**

310 D

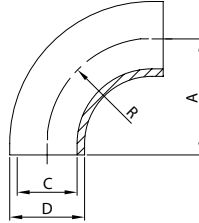

DN	A	C	D	R	gr
10	26,0	10,0	12,0	26,0	18
15	35,0	16,0	18,0	35,0	20
20	40,0	20,0	22,0	40,0	50
25	50,0	25,0	28,0	50,0	65
32	55,0	31,0	34,0	55,0	100
40	60,0	37,0	40,0	60,0	150
50	70,0	49,0	52,0	70,0	190
65	80,0	66,0	70,0	80,0	410
80	90,0	81,0	85,0	90,0	530
100	110,0	97,6	101,6	110,0	810
104	100,0	100,0	104,0	100,0	810
125	188,0	125,0	129,0	188,0	900

**CURVA 90° EM.
BEND 90° EE.
COUDE 90° BD.
CODO 90° EM.**

350 D

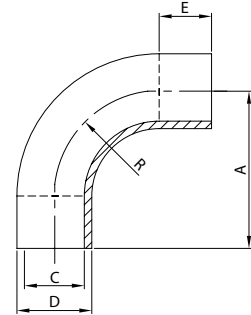

DN	A	C	D	E	R	gr
10	38,0	10,0	12,0	12,0	26,0	30
15	47,0	16,0	18,0	12,0	35,0	55
20	52,0	20,0	22,0	12,0	40,0	60
25	70,0	25,0	28,0	20,0	50,0	110
32	78,0	31,0	34,0	23,0	56,0	160
40	85,0	37,0	40,0	25,0	60,0	215
50	97,0	49,0	52,0	27,0	70,0	300
65	110,0	66,0	70,0	30,0	80,0	570
80	123,0	81,0	85,0	33,0	90,0	780
100	150,0	97,6	101,6	40,0	110,0	1.200
104	140,0	100,0	104,0	40,0	100,0	1.200

**CURVA 90° EM.
BEND 90° EE.
COUDE 90° BD.
CODO 90° EM.**

330 L

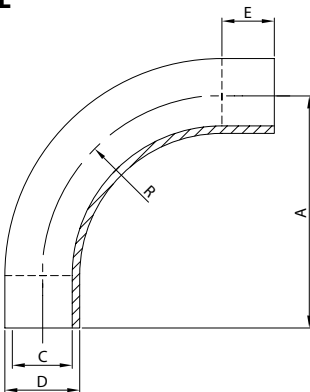

DN	A	C	D	E	R	gr
28	134,0	25,0	28,0	50,0	84,0	220
34	152,0	31,0	34,0	50,0	102,0	310
40	170,0	37,0	40,0	50,0	120,0	410
52	206,0	49,0	52,0	50,0	156,0	650
70	260,0	66,0	70,0	50,0	210,0	1.400
85	305,0	81,0	85,0	50,0	255,0	2.000
101	354,0	97,6	101,6	50,0	304,0	2.800
104	362,0	100,0	104,0	50,0	312,0	2.900

**CURVA 180° EL.
BEND 180° PE.
COUDE 180° BL.
CODO 180° EL.**

390 L

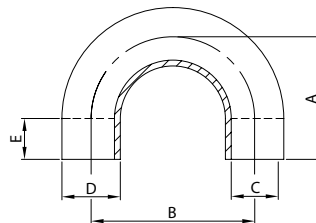

DN	A	B	C	D	E	gr
12	38,0	52,0	10,0	12,0	50,0	60
18	47,0	70,0	16,0	18,0	50,0	110
22	52,0	80,0	20,0	22,0	50,0	120
28	100,0	100,0	25,0	28,0	50,0	185
34	105,0	110,0	31,0	34,0	50,0	240
40	110,0	120,0	37,0	40,0	50,0	350
52	120,0	140,0	49,0	52,0	50,0	410
70	130,0	160,0	66,0	70,0	50,0	970
85	140,0	180,0	81,0	85,0	50,0	1.500
101	140,0	220,0	97,6	101,6	50,0	2.400
104	140,0	220,0	100,0	104,0	50,0	2.400



**CURVA 45° EL.
BEND 45° PE.
COUDE 45° BL.
CODO 45° EL.**

300 L

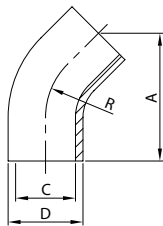

DN	A	C	D	R	gr
25	77,0	22,4	25,4	38,0	70
38	85,5	35,1	38,1	57,0	120
51	109,0	47,8	50,8	76,0	215
63	111,5	60,5	63,5	95,0	350
76	120,0	72,9	76,2	114,0	510
101	137,0	97,6	101,6	110,0	930
104	137,0	100,0	104,0	100,0	950

**CURVA 90° ES.
BEND 90° WE.
COUDE 90° BS.
CODO 90° ES.**

310 S

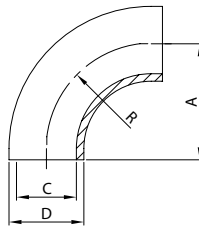

DN	A	C	D	R	gr
25	38,0	22,4	25,4	38,0	45
38	57,0	35,1	38,1	57,0	115
51	76,0	47,8	50,8	76,0	200
63	95,0	60,5	63,5	95,0	320
76	114,0	72,9	76,2	114,0	510
101	110,0	97,6	101,6	110,0	810
104	100,0	100,0	104,0	100,0	850

**CURVA 90° EM.
BEND 90° EE.
COUDE 90° BD.
CODO 90° EM.**

350 S

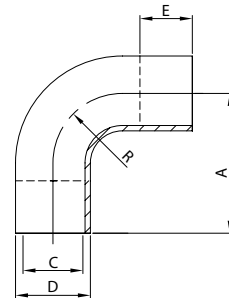

DN	A	C	D	E	R	gr
25	55,0	22,9	25,4	30,0	25,0	90
38	70,0	35,6	38,1	32,0	38,0	180
51	82,0	47,8	50,8	31,0	51,0	300
63	105,0	60,5	63,5	41,0	64,0	490
76	110,0	72,9	76,2	34,0	76,0	900
101	150,0	97,6	101,6	40,0	110,0	1.200
104	140,0	100,0	104,0	40,0	100,0	1.250

**CURVA 90° EM.
BEND 90° EE.
COUDE 90° BD.
CODO 90° EM.**

330 L

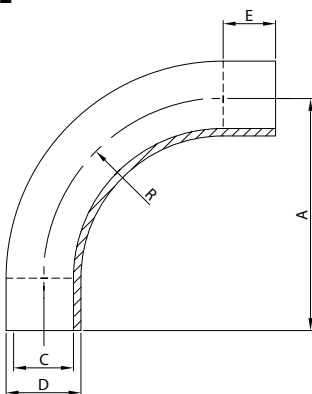

DN	A	C	D	E	R	gr
25	125,0	22,4	25,4	50,0	75,0	190
38	132,0	35,1	38,1	50,0	82,0	300
51	200,0	47,8	50,8	50,0	150,0	630
63	230,0	60,5	63,5	50,0	180,0	870
76	278,0	72,2	76,2	50,0	228,0	1.600
101	354,0	97,6	101,6	50,0	304,0	2.800

**CURVA 180° EL.
BEND 180° PE.
COUDE 180° BL.
CODO 180° EL.**

390 L

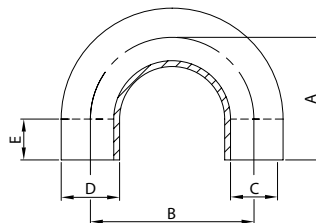

DN	A	B	C	D	E	gr
25	86,5	73,0	22,4	25,4	50,0	170
38	102,0	104,0	35,1	38,1	50,0	250
51	125,5	151,0	47,8	50,8	50,0	480
63	140,0	180,0	60,5	63,5	50,0	700
76	147,0	194,0	72,2	76,2	50,0	1.180
101	150,0	220,0	97,6	101,6	50,0	2.400
104	150,0	220,0	100,4	104,0	50,0	2.400



**CURVA 45° EL.
BEND 45° PE.
COUDE 45° BL.
CODO 45° EL.**

300 L

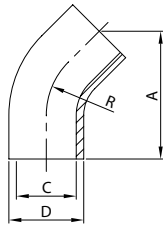

DN	A	C	D	R	gr
25	77,0	22,4	25,4	38,0	70
38	85,5	35,1	38,1	57,0	120
51	109,0	47,8	50,8	76,0	215
63	111,5	60,5	63,5	95,0	350
76	120,0	72,9	76,2	114,0	510
101	137,0	97,6	101,6	110,0	930
104	137,0	100,0	104,0	100,0	950

**CURVA 90° ES.
BEND 90° WE.
COUDE 90° BS.
CODO 90° ES.**

310 B

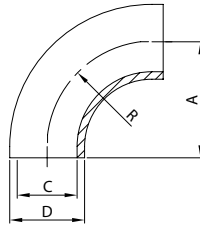

DN	A	C	D	R	gr
25	44,0	22,4	25,4	38,0	45
38	64,0	35,1	38,1	57,0	115
51	89,0	47,8	50,8	76,0	200
63	114,0	60,5	63,5	95,0	320
76	134,0	72,9	76,2	114,0	510
101	174,0	97,6	101,6	110,0	810

**CURVA 90° EM.
BEND 90° EE.
COUDE 90° BD.
CODO 90° EM.**

350 B

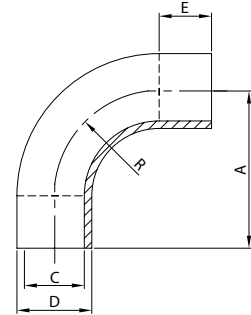

DN	A	C	D	E	R	gr
25	75,0	22,4	25,4	37,0	38,0	90
38	90,0	35,1	38,1	33,0	57,0	180
51	100,0	47,8	50,8	24,0	76,0	300
63	115,0	60,2	63,5	20,0	95,0	490
76	130,0	72,9	76,2	16,0	114,0	900
101	150,0	97,6	101,6	48,0	152,0	1.200

**CURVA 90° EM.
BEND 90° EE.
COUDE 90° BD.
CODO 90° EM.**

330 L

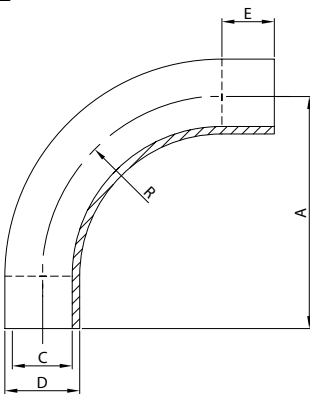

DN	A	C	D	E	R	gr
25	125,0	22,4	25,4	50,0	75,0	190
38	132,0	35,1	38,1	50,0	82,0	300
51	200,0	47,8	50,8	50,0	150,0	630
63	230,0	60,5	63,5	50,0	180,0	870
76	278,0	72,2	76,2	50,0	228,0	1.600
101	354,0	97,6	101,6	50,0	304,0	2.800

**CURVA 180° EL.
BEND 180° PE.
COUDE 180° BL.
CODO 180° EL.**

390 L

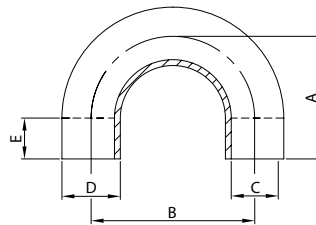

DN	A	B	C	D	E	gr
25	86,5	73,0	22,4	25,4	50,0	170
38	102,0	104,0	35,1	38,1	50,0	250
51	125,5	151,0	47,8	50,8	50,0	480
63	140,0	180,0	60,5	63,5	50,0	700
76	147,0	194,0	72,2	76,2	50,0	1.180
101	150,0	220,0	97,6	101,6	50,0	2.400
104	150,0	220,0	100,4	104,0	50,0	2.400



**CURVA 45° EL.
BEND 45° PE.
COUDE 45° BL.
CODO 45° EL.**

300 L

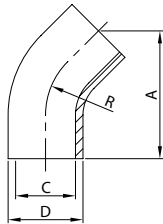

DN	A	C	D	R	gr
25	77,0	22,4	25,4	38,0	70
38	85,5	35,1	38,1	57,0	120
51	109,0	47,8	50,8	76,0	215
63	111,5	60,5	63,5	95,0	350
76	120,0	72,9	76,2	114,0	510
101	137,0	97,6	101,6	110,0	930
104	137,0	100,0	104,0	100,0	950

**CURVA 90° ES.
BEND 90° WE.
COUDE 90° BS.
CODO 90° ES.**

310 I

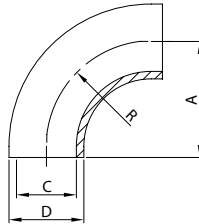

DN	A	C	D	R	gr
25	38,0	22,4	25,4	38,0	45
38	57,0	35,1	38,1	57,0	115
51	76,0	47,8	50,8	76,0	200
63	95,0	60,5	63,5	95,0	320
76	114,0	72,9	76,2	114,0	510
101	150,0	97,6	101,6	110,0	810

**CURVA 90° EM.
BEND 90° EE.
COUDE 90° BD.
CODO 90° EM.**

350 I

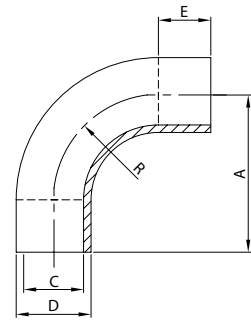

DN	A	C	D	E	R	gr
25	65,0	22,1	25,4	27,0	38,0	90
38	85,0	34,8	38,1	28,0	57,0	180
51	110,0	47,5	50,8	34,0	76,0	300
63	135,0	60,2	63,5	40,0	95,0	490
76	155,0	72,9	76,2	41,0	114,0	900
101	185,0	97,6	101,6	43,0	150,0	1.200

**CURVA 90° EM.
BEND 90° EE.
COUDE 90° BD.
CODO 90° EM.**

330 L

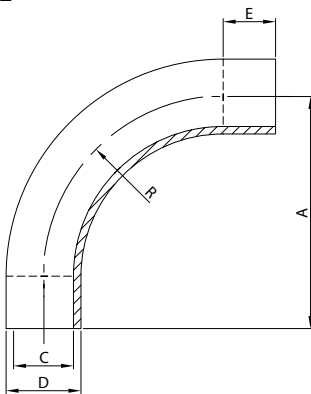

DN	A	C	D	E	R	gr
25	125,0	22,4	25,4	50,0	75,0	190
38	132,0	35,1	38,1	50,0	82,0	300
51	200,0	47,8	50,8	50,0	150,0	630
63	230,0	60,5	63,5	50,0	180,0	870
76	278,0	72,2	76,2	50,0	228,0	1.600
101	354,0	97,6	101,6	50,0	304,0	2.800

**CURVA 180° EL.
BEND 180° PE.
COUDE 180° BL.
CODO 180° EL.**

390 L

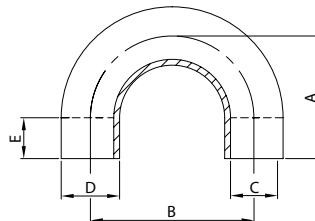

DN	A	B	C	D	E	gr
25	86,5	73,0	22,4	25,4	50,0	170
38	102,0	104,0	35,1	38,1	50,0	250
51	125,5	151,0	47,8	50,8	50,0	480
63	140,0	180,0	60,5	63,5	50,0	700
76	147,0	194,0	72,2	76,2	50,0	1.180
101	150,0	220,0	97,6	101,6	50,0	2.400
104	150,0	220,0	100,4	104,0	50,0	2.400



**CURVA 45° EL.
BEND 45° PE.
COUDE 45° BL.
CODO 45° EL.**

W2K

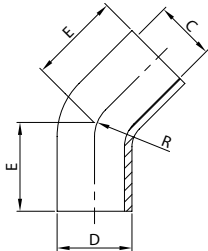

DN	C	D	E	R	gr
1/2" 12	9,4	12,7	57,1	44,4	40
3/4" 19	15,7	19,0	57,1	66,5	75
1" 25	22,1	25,4	30,2	38,1	50
1 1/2" 38	34,8	38,1	41,3	57,2	100
2" 51	47,5	50,8	58,7	76,2	180
2 1/2" 63	60,2	63,5	76,2	95,3	200
3" 76	72,9	76,2	93,7	114,3	500
4" 101	97,4	101,6	122,3	152,4	800

**CURVA 45° E. SM.
BEND 45° E. FR.
COUDE 45° B. FR.
CODO 45° E. SM.**

K2K

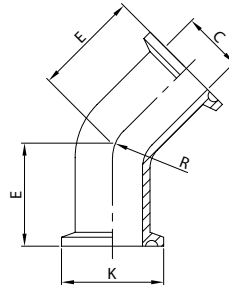

DN	C	E	K	R	gr
1/2" 12	9,4	69,8	25,0	44,4	70
3/4" 19	15,7	69,8	25,0	66,5	100
1" 25	22,1	28,6	50,5	38,1	120
1 1/2" 38	34,8	36,5	50,5	57,2	141
2" 51	47,5	44,5	64,0	76,2	227
2 1/2" 63	60,2	52,4	77,5	95,3	259
3" 76	72,9	60,3	91,0	114,3	540
4" 101	97,4	79,4	119,0	152,4	1.020

**CURVA 90° ES.
BEND 90° WE.
COUDE 90° BS.
CODO 90° ES.**

310 LA

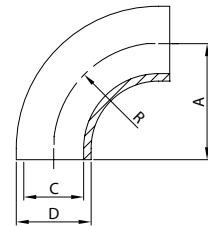

DN	A	C	D	R	gr
1" 25	38,0	22,1	25,4	38,0	50
1 1/2" 38	57,0	34,8	38,1	57,0	120
2" 51	76,0	47,5	50,8	76,0	205
2 1/2" 63	95,0	60,2	63,5	95,0	325
3" 76	114,0	72,9	76,2	114,0	515
4" 101	152,0	97,4	101,6	152,0	815

**CURVA 90° ES.
BEND 90° WE.
COUDE 90° BS.
CODO 90° ES.**

320 LA

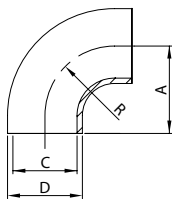

DN	A	C	D	R	gr
1" 25	25,0	22,1	25,4	25,0	40
1 1/2" 38	38,0	34,8	38,1	38,0	100
2" 51	51,0	47,5	50,8	51,0	180
2 1/2" 63	64,0	60,2	63,5	64,0	295
3" 76	76,0	72,9	76,2	76,0	480
4" 101	101,0	97,4	101,6	101,0	770

**CURVA 90° EM.
BEND 90° EE.
COUDE 90° BD.
CODO 90° EM.**

W2C

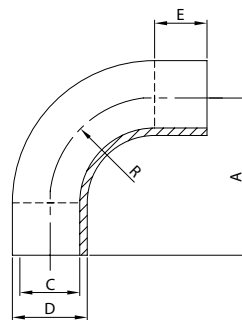

DN	A	C	D	E	R	gr
1/2" 12	76,2	9,4	12,7	31,8	44,4	56
3/4" 19	76,2	15,7	19,0	9,7	66,5	95
1" 25	52,4	22,1	25,4	14,3	38,1	160
1 1/2" 38	74,6	34,8	38,1	17,4	57,2	180
2" 51	103,2	47,5	50,8	27,0	76,2	340
2 1/2" 63	131,8	60,2	63,5	36,5	95,3	460
3" 76	160,3	72,9	76,2	46,0	114,3	700
4" 101	211,1	97,4	101,6	58,7	152,4	1.300

**CURVA 90° E. SM.
BEND 90° E. FR.
COUDE 90° B. FR.
CODO 90° E. SM.**

K2C

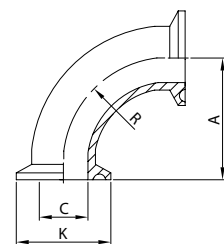

DN	A	C	K	R	gr
1/2" 12	88,8	9,4	25,0	44,4	90
3/4" 19	88,8	15,7	25,0	66,5	120
1" 25	50,8	22,1	50,5	38,1	170
1 1/2" 38	69,9	34,8	50,5	57,2	200
2" 51	88,9	47,5	64,0	76,2	370
2 1/2" 63	108,0	60,2	77,5	95,3	500
3" 76	127,0	72,9	91,0	114,3	910
4" 101	168,3	97,4	119,0	152,4	1.660



**CURVA 180° EL.
BEND 180° PE.
COUDE 180° BL.
CODO 180° EL.**

W3C

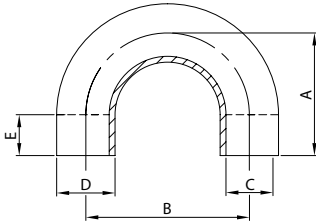

DN	A	B	C	D	E	gr
1" 25	86,5	73,0	22,1	25,4	50,0	170
1 1/2" 38	102,0	104,0	34,8	38,1	50,0	320
2" 51	125,5	151,0	47,5	50,8	50,0	500
2 1/2" 63	140,0	180,0	60,2	63,5	50,0	740
3" 76	147,0	194,0	72,9	76,2	50,0	1.180
4" 101	150,0	220,0	97,4	101,6	50,0	1.980

**CURVA 180° E. SM.
BEND 180° E. FR.
COUDE 180° B. FR.
CODO 180° E. SM.**

K3C

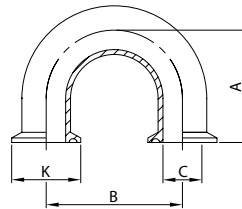

DN	A	B	C	K	gr
1" 25	99,2	73,0	22,1	50,5	340
1 1/2" 38	114,7	104,0	34,8	50,5	400
2" 51	138,2	151,0	47,5	64,0	740
2 1/2" 63	152,7	180,0	60,2	77,5	1.000
3" 76	159,7	194,0	72,9	91,0	1.820
4" 101	165,8	220,0	97,4	119,0	3.320

FLLITASSALINI OFFICINA MECCANICA S.P.A.
Via G. Di Vittorio 19/21 - 20068 Peschiera Borromeo (MI) - Italy
Tel. (+39) 02 55 38 311 - Fax (+39) 02 54 73 441
www.tassalini.com
info@tassalini.it